









KENMORE PRESSURE GAUGES

-  Rugged all-welded stainless steel construction
-  Suitable for a wide variety of industries & applications
-  2-1/2" dials with psi or psi/bar scale, optional liquid fill
-  NPT or tube adapter end connections
-  NEMA 4X/IP65 rated for indoor and outdoor use
-  Available with cleaning for oxygen service

Materials of Construction

Core Tube	316 Stainless Steel
Socket	316 Stainless Steel
Case	304 Stainless Steel
Lens	Polycarbonate

Dimensions

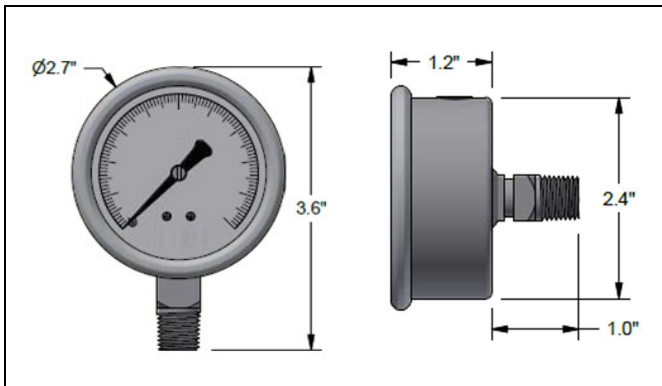

Temp Ratings

Ambient	-40°F to 150°F (-40°C to 65°C)
Process	-40°F to 250°F (-40°C to 121°C)

Environmental Protection

Nema 4X/IP65

Accuracy

±1.6% ASME Grade B+, EN 837-1

Ordering Information

psi scale, bottom mount 1/4" NPT	
0-60 psi	316-PG-25-P60-B-M4N
0-100 psi	316-PG-25-P160-B-M4N
0-160 psi	316-PG-25-P160-B-M4N
0-200 psi	316-PG-25-P200-B-M4N
0-300 psi	316-PG-25-P300-B-M4N
0-400 psi	316-PG-25-P400-B-M4N
0-800 psi	316-PG-25-P800-B-M4N
0-3000 psi	316-PG-25-P3000-B-M4N
0-5000 psi	316-PG-25-P5000-B-M4N

psi/bar scale, bottom mount 1/4" NPT	
0-60 psi/bar	316-PG-25-PB60-B-M4N
0-100 psi/bar	316-PG-25-PB160-B-M4N
0-160 psi/bar	316-PG-25-PB160-B-M4N
0-200 psi/bar	316-PG-25-PB200-B-M4N
0-300 psi/bar	316-PG-25-PB300-B-M4N
0-400 psi/bar	316-PG-25-PB400-B-M4N
0-800 psi/bar	316-PG-25-PB800-B-M4N
0-3000 psi/bar	316-PG-25-PB3000-B-M4N
0-5000 psi/bar	316-PG-25-PB5000-B-M4N

*Contact us for additional options

